

# SPIROTECH SPECIFICATION SHEET



Product: SpiroCombi Hi-flow  
DN80 Weld end

Type:  
Date:

HC080L  
11/19/2019

Customer:

Project:

Reference:

## Design criteria

Medium:	Water / glycol (max 50%)	
Max. flow velocity:	3	m/s
Max. flow rate:	54.0	m <sup>3</sup> /h
Max. pressure:	10	bar-g
Max. temperature:	110	°C
Δp at max. flow:	12.4	kPa
Design standard:	EN 13445	

## Testing and quality assurance

Test pressure (bar):	7
Test medium:	Air
Test certificate:	no
Design and manufacturing acc. 2014/68/EU:	yes
Material certificates (structural parts):	no
Drawing:	no
Weld procedures:	no
Nondestructive Testing (X-ray: 10%):	no
Notified body inspection:	no

## Construction materials

Body:	S235 JR G2 (St.37)
Connections:	S235 JR G2 (St.37)
Fittings:	S235 JR G2 (St.37)
Heads:	S235 JR G2 (St.37)
Deaeration cap:	Brass
Valve sealing:	Viton
Float:	PP
Spirotube Tube:	S235 JR G2 (St.37)
Spirotube Wire:	Copper
Spirotube Solder:	Tin(SnCu3)
Paint:	Standard
Color:	Yellow (RAL 1003)
Drain valve:	Nickeled brass

## Drawing

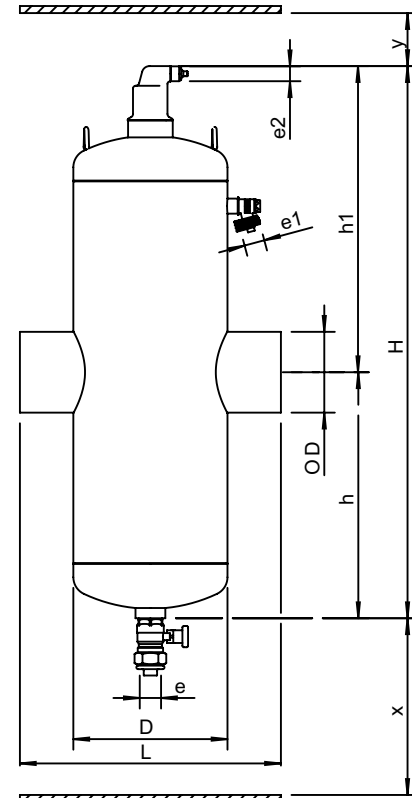

## Dimensions

DN:	80
OD:	88.9 mm
H:	1145 mm
h:	525 mm
h1:	620 mm
D:	219 mm
L:	370 mm
e:	Rp1
e1:	G3/4
e2:	R1/2
x:	>200 mm
y:	>50 mm

Volume:	37 ltr
Dry weight (approx):	36 kg

Subject to changes