

SPIROTECH SPECIFICATION SHEET



Product: SpiroTrap Rp1" Threaded fitting

Type:

UE100WJ

Date:

6/21/2021

Customer:

Project:

Reference:

Design criteria

Medium:	Water / glycol (max 50%)	
Max. flow velocity:	1	m/s
Max. flow rate:	2.00	m ³ /h
Max. pressure:	10	bar-g
Max. temperature:	110	°C
Design standard:	EN 13445	

Testing and quality assurance

Leakage test:	no
Test certificate:	no
Design and manufacturing acc. 2014/68/EU:	yes
Material certificates (structural parts):	no
Drawing:	no

Construction materials

Body:	Brass
Swivel:	Brass
Drain valve:	Brass
Spirotube Tube:	Copper
Spirotube Wire:	Copper
Spirotube Solder:	Tin(SnCu3)
Magnet:	Neodymium

Drawing

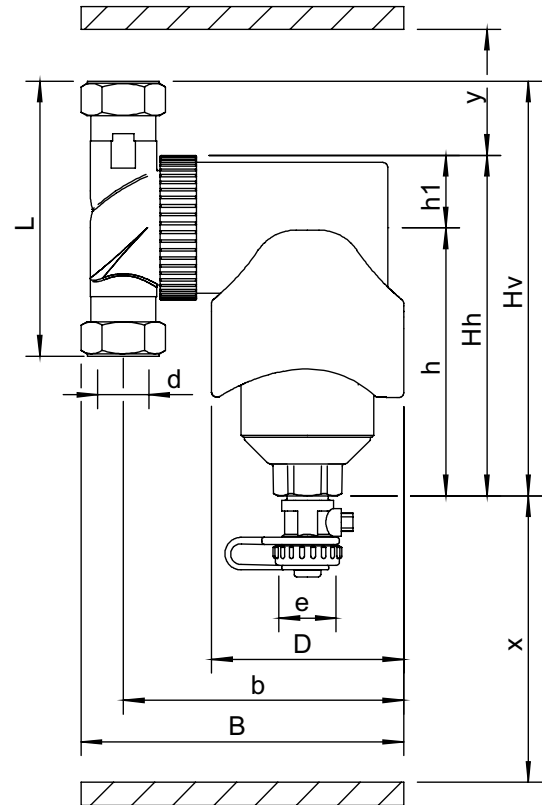

Dimensions

d:	Rp1"
h:	117 mm
Hh:	149 mm
Hv:	162 mm
h1:	32 mm
L:	90 mm
D:	84 mm
B:	152 mm
b:	129 mm
x:	>110 mm
y:	>50 mm
e:	G3/4

Volume 0.39 ltr

Dry weight (approx) 2.3 kg

Subject to changes