

Product data sheet Spirotech

Product name

SpiroCombi -DN125 -Magnet -Flange

Product properties

A steel (microbubble) deaerator and dirt separator with magnet for standard flow rate (1.5 m/s) with a DN50 - DN300 PN16 flange connection

- Combined separation system - removes circulating air and microbubbles effectively
- Improve cost control and energy efficiency
- Applicable with 50/50 Ethylene Glycol / Water (Volume)
- Very small particles, from $5\ \mu\text{m}$ (= 0.005 mm), are separated and removed
- Including a magnet for extra protection and high efficient removal of magnetite
- Dirt can be discharged while the system is in operation
- No shut-off valves or bypass required
- Constant low pressure drop
- PN16 flange connections
- Connection diameters from DN50 - DN300, larger connection diameters on request
- Exceptional guarantee

Article number

BC125FM

Product image



Product dimensions

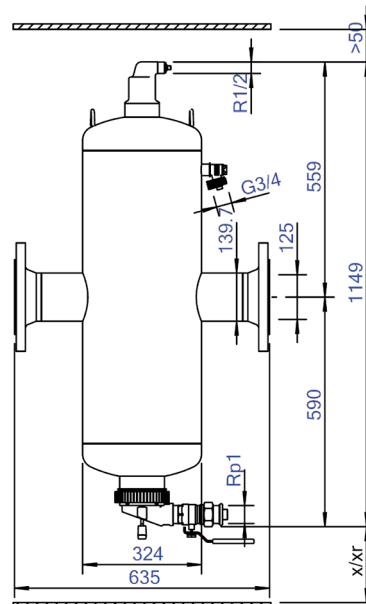

Product data sheet Spirotech

ETIM product data

Housing material	Steel	Article compression class	PN 10
With drain tap	Yes	Surface protection	Lacquered
Housing material quality	St 37 (1.0254)	Suitable for open system	No
Backwash filter	No	Suitable for closed system	Yes
Medium temperature (continuous)	0 - 110 °C	Suitable for solar	No
Max. operating pressure	10 bar	With dismountable filter	No
Kvs value	350.7	Filter volume	50 l
Variable flow direction	Yes	Magnet operating principle	Yes
With insulation	No	With automatic de-aerator	Yes
Separator type	Air/dirt	Cleaning possible during operation	Yes
Connection	Flange	With couplers	No
Model	Horizontal	Inlet/outlet offset distance	0 mm
Nominal diameter	DN 125	Material of connection	Steel
Max. glycol mixture	50 %	Flow-through capacity	0 - 72 m ³ /h
Suitable for heating	Yes	Magnet location	Internal
Suitable for cooling	Yes	Flange standard	DIN
Construction length	635 mm		

Disclaimer

This product sheet has been compiled with the greatest possible care. Nevertheless, it may contain errors or omissions. For the most current and correct information we refer you to our website.

