

Product data sheet Spirotech

Product name

EMCK Duo 500L max 8,1bar Twin

Product properties

The MultiControl Kompakt DUO Twin is an automatic expansion and pressure-maintaining device. The unit contains 2 pumps (2x 50%) and 2 overflow valves. An unpressurised expansion tank is integrated.

- 2 pumps (2x 50%)
- 2 overflow valves (2x 100%)
- Comes with 6 possible vessel volumes: 45, 75, 125, 200, 300 or 500 liters
- Two further unpressurized expansion vessels can be added
- Operational pressure range up to 8.1 bar
- Maximum expansion volume: 45 – 1,500 liters
- The maximum temperature at the point of connection: 70°C (over 70°C possible with auxiliary tank)
- Maximum safety temperature in the system: 110°C
- Maximum operating pressure (PN): 10 bar

Article number

EMCK-D500-8.1-twin

Product image



Product dimensions

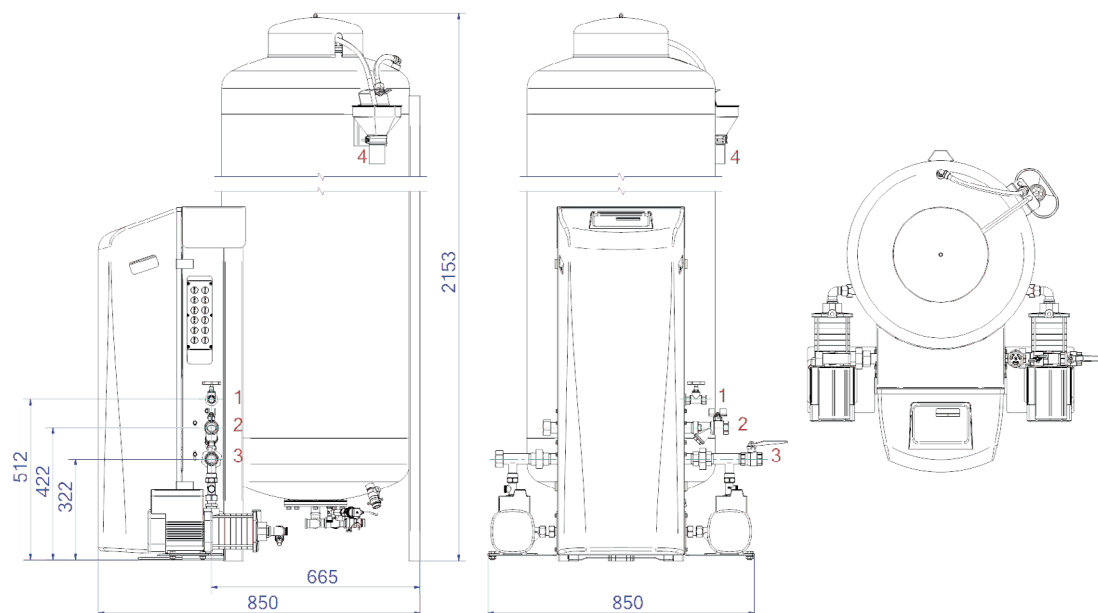

1. Refill connection

Rp1/2

3. Expansion pressure pipe

Rp1

2. Expansion overflow pipe

Rp1

4. Drain funnel tank safety valve

DN50 Geberit

Product data sheet Spirotech

ETIM product data

Height	2130 mm
Volume	500 l
Max. operating pressure	8.1 bar
Connection	Other
Power consumption	1.5 kW
Couplable	Yes
Electrical connection	Connection cable with plug
Function master/slave	No
With pressure expansion vessel	Yes
Digital control unit	Yes

Double pump/compressor unit	Yes
With exchangeable membrane	Yes
Compressor in base	No
Nominal diameter expansion connection	1 inch (25)
Max. medium temperature (continuous)	70 °C
For heating systems up to	1 MW
Horizontal positioning	No
Connection voltage	230 V
Article compression class	PN 10

Disclaimer

This product sheet has been compiled with the greatest possible care. Nevertheless, it may contain errors or omissions. For the most current and correct information we refer you to our website.

