

# Product data sheet Spirotech

Product name

**Primary vessel 3000L for EMCM, ETCM**

Product properties

Expansion vessels for EMCM and ETCM, P max. 0,5 bar / T max. 70°C

Article number

**EP3000R**

Product image



Product dimensions

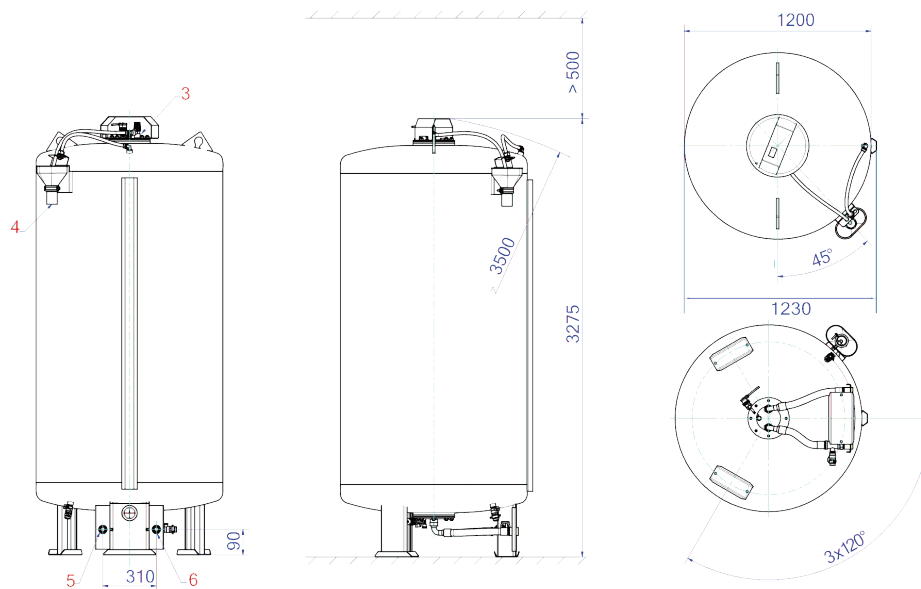

# Product data sheet Spirotech

## ETIM product data

Height	3275 mm
Volume	3000 l
Colour	Other
Diameter	1200 mm
Medium temperature (continuous)	0 - 70 °C
Max. operating pressure	0.5 bar
With pressure gauge	No
With exchangeable membrane	Yes
Nominal diameter expansion connection	1 1/4 inch (32)
Horizontal positioning	No
Suitable for central heating	Yes
Vertical positioning	Yes
With legs	Yes

Material membrane/bladder	Other
Flange compression class	Other
With drain	Yes
Tilting height	3500 mm
With safety valve	Yes
Max. glycol mixture	60 %
Suitable for tap water	No
Max. ethanol mixture	60 %
Suitable for solar collector circuit	Yes
Pre-pressure	0 bar
With fixed wall support	No
Suitable for cooling	No

### Disclaimer

This product sheet has been compiled with the greatest possible care. Nevertheless, it may contain errors or omissions. For the most current and correct information we refer you to our website.

