

Product data sheet Spirotech

Product name

ETCM Solo-4.7 max 23,5bar

Product properties

The TopControl Modular SOLO is an automatic expansion and pressure-maintaining device. The unit contains a VFD pump (1x 100%) and an electronically controlled overflow valve. An unpressurised expansion tank is required.

- 1 VFD pump (1x 100%)
- 1 electronically controlled overflow valve (1x 100%)
- At least 1 unpressurised expansion vessel needs to be added
- Operational pressure range up to 8.4 to 23.5 bar
- The maximum temperature at the point of connection: 70°C (over 70°C possible with auxiliary tank)
- Maximum safety temperature in the system: 110°C
- Maximum operating pressure (PN): 10 to 25 bar

Article number

ETCM-S4.7-23.5

Product image



Product dimensions

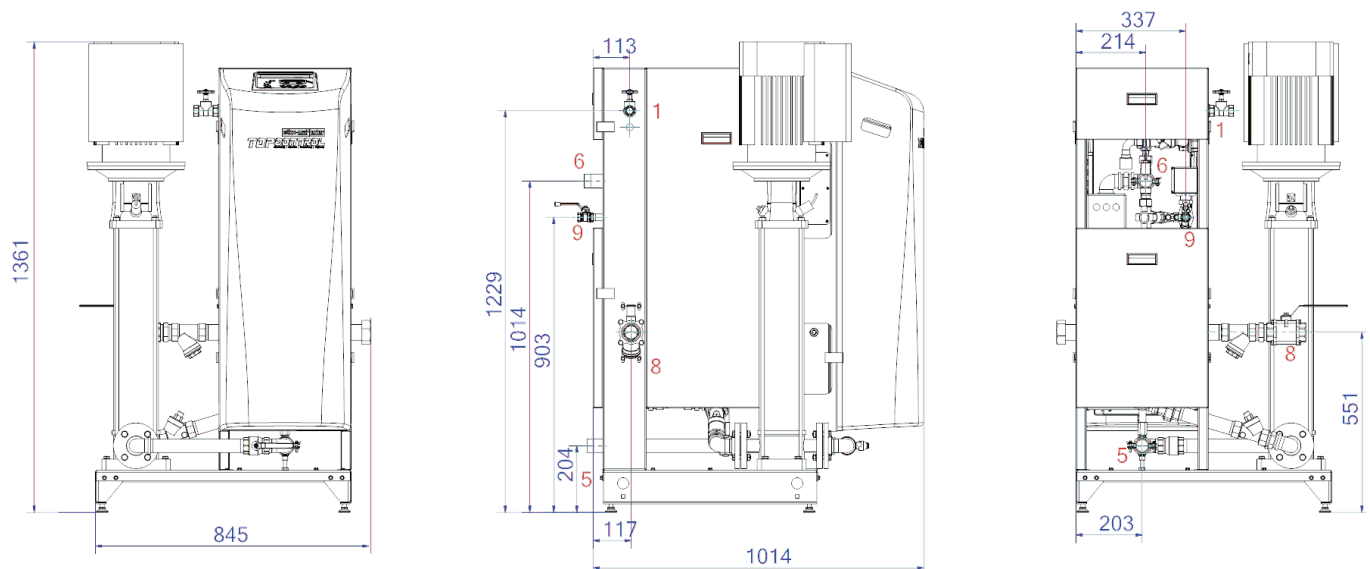

1. Refill connection	Rp1/2, Rp3/4
5. Suction line from expansion vessel	R5/4
6. Overflow line to the expansion tank	R5/4

8. Expansion pressure pipe	Rp6/4
9. Degassing pipe	Rp1/2

Product data sheet Spirotech

ETIM product data

Height	1361 mm	Double pump/compressor unit	No
Max. operating pressure	23.5 bar	With exchangeable membrane	No
Connection	Other	Compressor in base	No
Power consumption	3.2 kW	Nominal diameter expansion connection	1 1/2 inch (40)
Couplable	Yes	Max. medium temperature (continuous)	70 °C
Electrical connection	Connection cable with plug	For heating systems up to	1 MW
Function master/slave	No	Horizontal positioning	No
With pressure expansion vessel	No	Connection voltage	400 V
Digital control unit	Yes	Article compression class	PN 25

Disclaimer

This product sheet has been compiled with the greatest possible care. Nevertheless, it may contain errors or omissions. For the most current and correct information we refer you to our website.

