

Product data sheet Spirotech

Product name

SpiroTrap -DN150 -HiFlow -Flange

Product properties

A steel dirt separator for high flow rate (3 m/s) with a DN50 - DN300 PN16 flange connection

- Applicable for high flow rate systems (3 m/s)
- Applicable with 50/50 Ethylene Glycol / Water (Volume)
- Very small particles, from 5 μm (= 0.005 mm) are separated and removed
- Dirt can be drained while the system is in operation
- No shut-off valves or bypass required
- Constant low pressure drop
- Maintenance only takes a few seconds
- No unnecessary downtime
- PN16 flange connections
- Connection diameters from DN50 - DN300, larger connection diameters on request

Article number

HE150F

Product image



Product dimensions

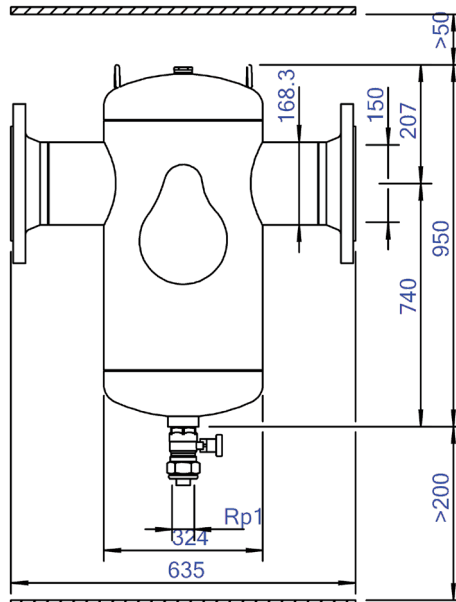

Product data sheet Spirotech

ETIM product data

Housing material	Steel	Suitable for open system	No
With drain tap	Yes	Suitable for closed system	Yes
Housing material quality	St 37 (1.0254)	Suitable for solar	No
Backwash filter	No	Whirl operating principle	No
Medium temperature (continuous)	0 - 110 °C	Negative pressure operating principle	No
Max. operating pressure	10 bar	With dismountable filter	No
Kvs value	490.9 m ³ /h	Filter volume	75 l
Variable flow direction	Yes	Magnet operating principle	No
With insulation	No	Thrust operating principle	No
Separator type	Dirt	With automatic de-aerator	No
Connection	Flange	Partial flow principle	No
Model	Horizontal	Principle full flow with settling	Yes
Nominal diameter	DN 150	Cleaning possible during operation	Yes
Max. glycol mixture	50 %	With couplers	Yes
Suitable for heating	Yes	Inlet/outlet offset distance	0 mm
Suitable for cooling	Yes	Material of connection	Steel
Construction length	635 mm	Flow-through capacity	0 - 215 m ³ /h
Article compression class	PN 10	Flange standard	DIN
Surface protection	Lacquered		

Disclaimer

This product sheet has been compiled with the greatest possible care. Nevertheless, it may contain errors or omissions. For the most current and correct information we refer you to our website.

